

SCF-150.75Z

Fixed Type Vacuum Capacitor(FS36 Type)

Specification

Peak Test Voltage	15kV,peak (at 50,60 Hz/ 1 minute)
RF Working Voltage	9 kV,peak (at 13.56 MHz)
Capacitance	75 pF
Maximum Current	40 A,rms (at 13.56 MHz)
Total Length	43 mm
Outer Diameter	φ36 mm
Mounting Length	43 mm
Weight	0.13 kg



Drawing

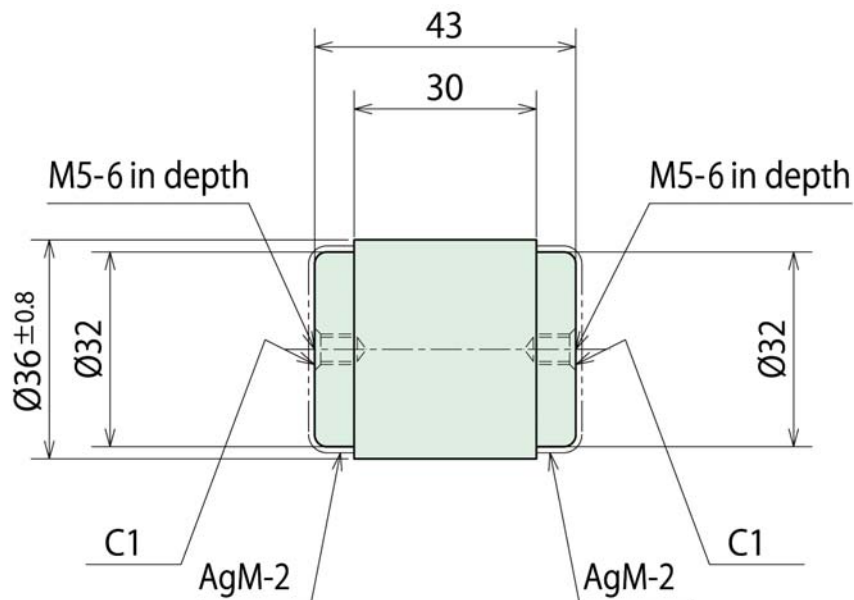

SCF-150.75Z

Fixed Type Vacuum Capacitor(FS36 Type)

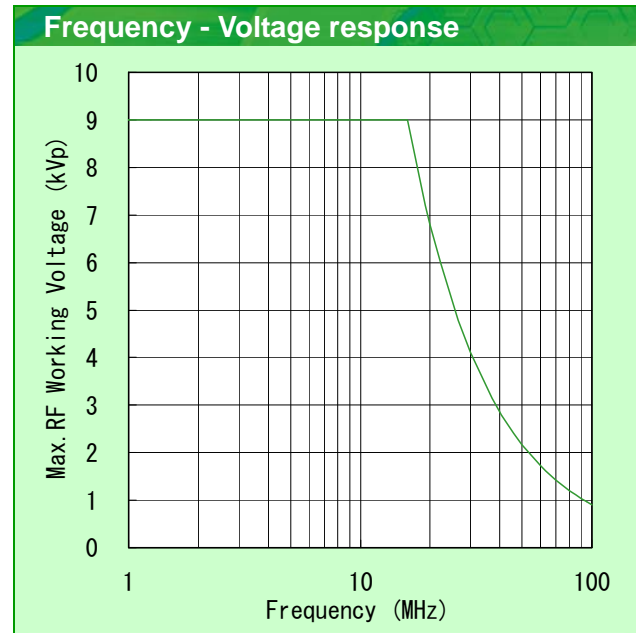
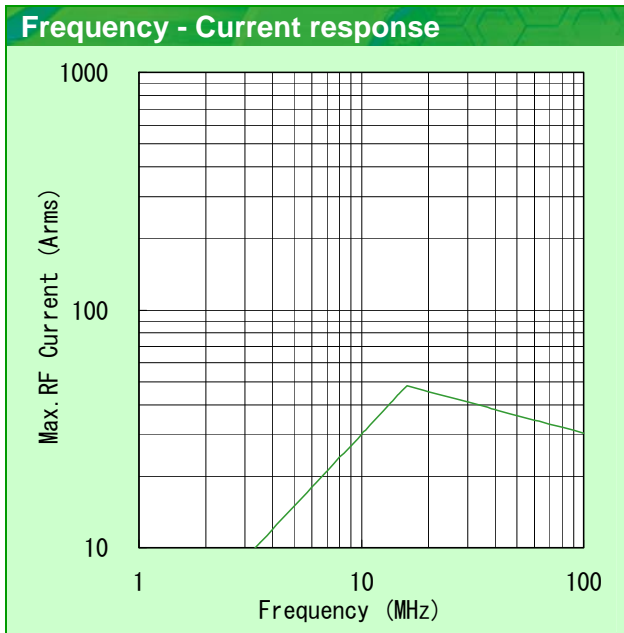

Notice:

- Current collecting system: Capacitor both-end full-face collection.
- Cooling System: Convection.
- Permissible surface temperature: 125°C.
(The surface temperature changes with current collecting conditions and ambient temperature.)
- Ambient temperature: 25°C.

MEIDENSHA CORPORATION

ThinkPark Tower 2-1-1 Oosaki, Shinagawa-ku, Tokyo, 141-6029 Japan

Phone: 81-3-6420-7510 Facsimile: 81-3-5745-3053 URL: www.meidensha.co.jp